

# ZUBEHÖR FÜR SCHLEIFDORNE ACCESSORIES FOR GRINDING WHEEL HOLDERS

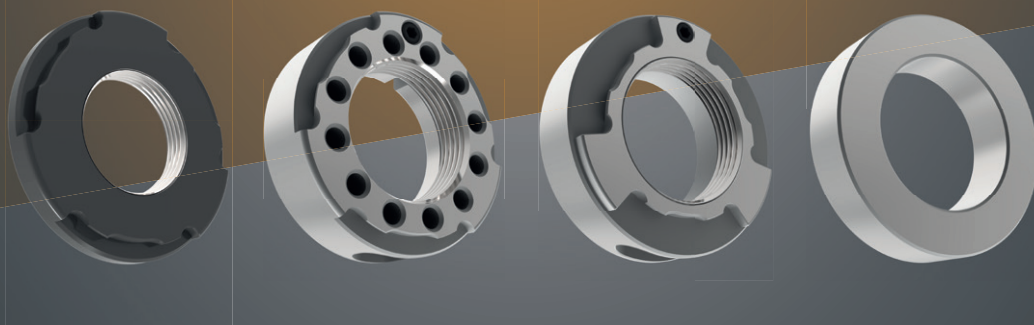

ZETA Sicherheitsspannscheiben • Bedienelemente • Zwischenringe • Montagevorrichtungen  
*ZETA safety clamping disc • operating tools • spacers • mounting devices*

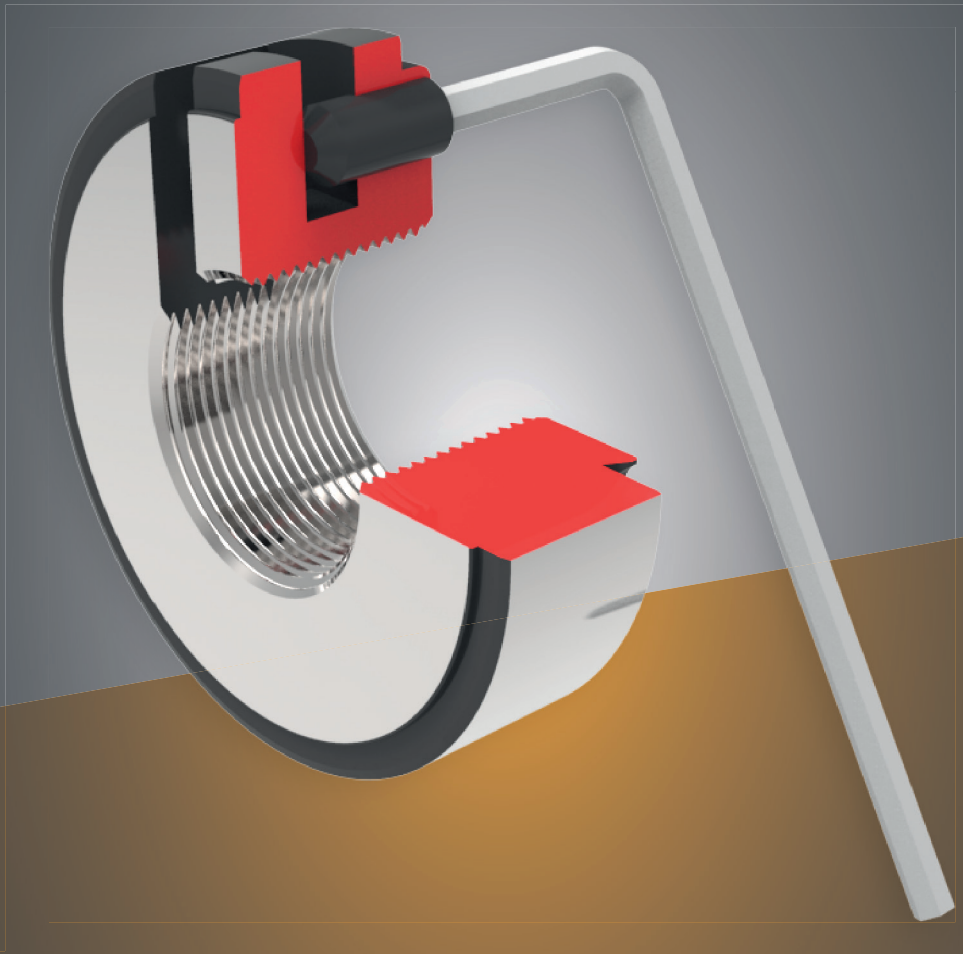

T-TOOL PRECISION GmbH • Talheimer Straße 10 • D-72393 Burladingen  
Phone: +49 7126 9292-25 • Mail: t-tool@t-tool.de • Website: www.t-tool.de



# SPANNSCHEIBEN

## CLAMPING NUTS

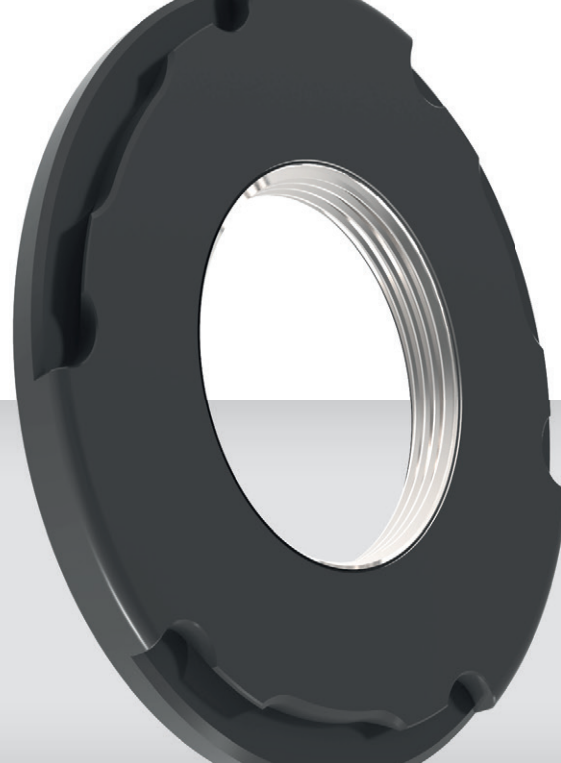

### ZETA-SPANNSCHEIBEN für Schleifdorne

ZETA-clamping nut for grinding wheel holders

D	B	C	Profil Profile	Artikelnummer Part number
35	5	M20x1,0	<b>K</b>	SPS02013505Zeta
40	5	M20x1,0	<b>K</b>	SPS02014005Zeta
42	5	M20x1,0	<b>K</b>	SPS02014205Zeta
42	5	M20x1,0	<b>L</b>	SPS020142E05Zeta
50	6	M20x1,0	<b>M</b>	SPS02015006Zeta
50	6	M30x1,0	<b>M</b>	SPS03015006Zeta

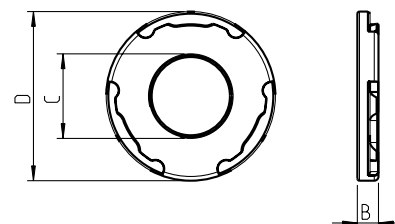

### SICHERHEITSPANNSCHEIBE für Schleifdorne

Safety clamping nut for grinding wheel holders

D	B	C	Profil Profile	Artikelnummer Part number
40	5	M20x1,0	-	SPS0210

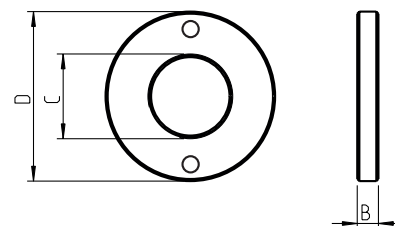

# SPANNSCHEIBEN

## CLAMPING NUTS

### ZETA-KLEMM-SPANNSCHEIBE für Schleifdorne

ZETA-clamping nut for grinding wheel holders

D	B	C	Profil Profile	Artikelnummer Part number
42	15	M20x1,0	I	SPSK020104215Zeta
42	15	M20x1,5	I	SPSK020154215Zeta
50	15	M30x1,5	I	SPSK030155015Zeta

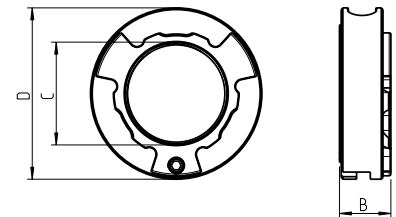

### ZETA-WUCHT-SPANNSCHEIBE mit 12 Löchern

ZETA-balance clamping nut with 12 holes

D	B	C	Profil Profile	Artikelnummer Part number
42	15	M20x1,0	I	SPSKW020104215Zeta
42	15	M20x1,5	I	SPSKW020154215Zeta
50	15	M30x1,5	M	SPSKW030155015Zeta

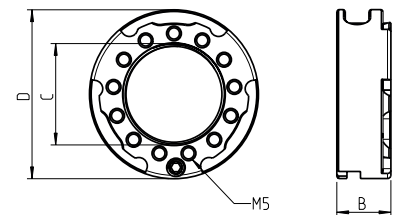

### ZETA-SPANNMUTTER für Kombischleifdorne

ZETA-Clamping nut for combi-grinding wheel holders

Typ Type	A	B	C	Profil Profile	Artikelnummer Part number
ER 16 Zeta*	27	18	M20x1,0	C	SPAMUERXP16Zeta
ERM 16 Zeta	22	17	M19x1,0	C	SPAMUERM16Zeta
ERM 20 Zeta	28	19	M24x1,0	D	SPAMUERM20Zeta

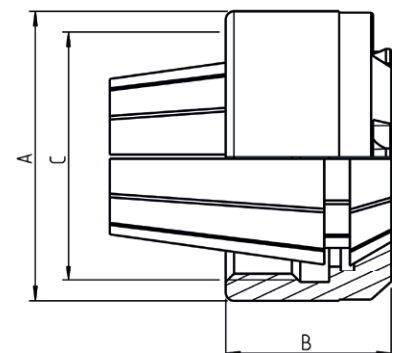

\* nur für Kombischleifdorn D20

\* only for combined grinding wheel holder D20

# WUCHTRINGE

## BALANCE RINGS



### STANDARD WUCHTRING horizontal

Standard balance ring horizontal

D	d	B	BA*	Artikelnummer Part number
42	20	8	15	WUHRH04220
42	31.75	8	15	WUHRH04231.75
50	20	8	15	WUHRH05020
50	31.75	8	15	WUHRH05031.75

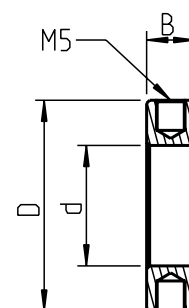

### STANDARD WUCHTRING vertikal

Standard balance ring vertical

D	d	B	BA*	Artikelnummer Part number
58	20	13	18	WUHRV05820
58	31.75	13	18	WUHRV05831.75
66	20	13	18	WUHRV06620
66	31.75	13	18	WUHRV06631.75

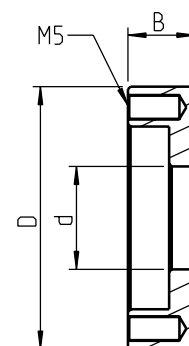

\*BA = Anzahl der Bohrungen | \*BA = number of drilled holes

### SCHRAUBENSET Für Wuchtringe

Screw set for balance rings

Anzahl Peaces	Typ Type	Größe Size	Artikelnummer Part number
10	DIN931	M5x4	SCRSM54565x4
10	DIN931	M5x5	SCRSM54565x5
10	DIN931	M5x6	SCRSM54565x6

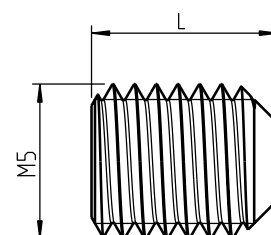

# SPANNSCHEIBE MIT 4 NUTEN

## CLAMPING NUT WITH 4 GROOVES



**ZETA-SPANNSCHEIBE** mit 4 Nuten (Hawema / Häberle)  
*ZETA-clamping nut with 4 grooves (Hawema / Häberle)*

D	B	C	Artikelnummer Part number
40	5	M20x1	SPSHAW2010Zeta

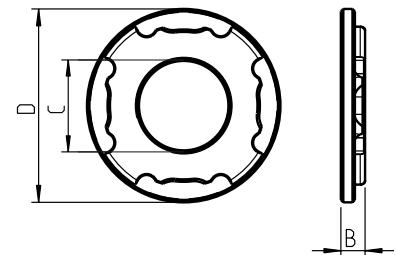

**ZETA-EINDREHHILFE** mit 4 Nuten  
*ZETA-torque nut*

Typ Type	A	H	SW	V	Artikelnummer Part number
ED 32 Zeta-4	ø38	21	30	-	SCHED32Zeta-4

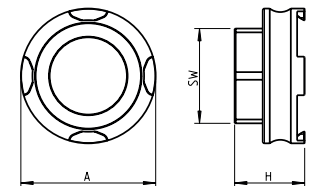

**ZETA-DREHMOMENTSTECKNUSS** mit 4 Nuten  
*ZETA-Screw-on-adapter*

Typ Type	A	H	SW	V	Artikelnummer Part number
EC 32 Zeta-4	ø38	97	27	1/2"	STEC32Zeta-4

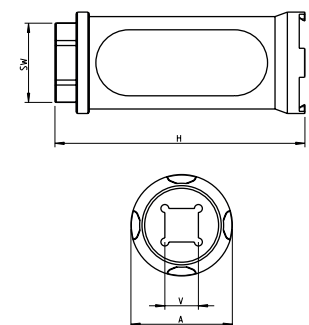

**ZETA-SPANNSCHLÜSSEL** mit 4 Nuten  
*ZETA-Standard spanner wrench*

Typ Type	A	L	Artikelnummer Part number
E 32 Zeta-4	ø38	220	SCHE32Zeta-4





# BEDIENELEMENTE

## OPERATING TOOLS

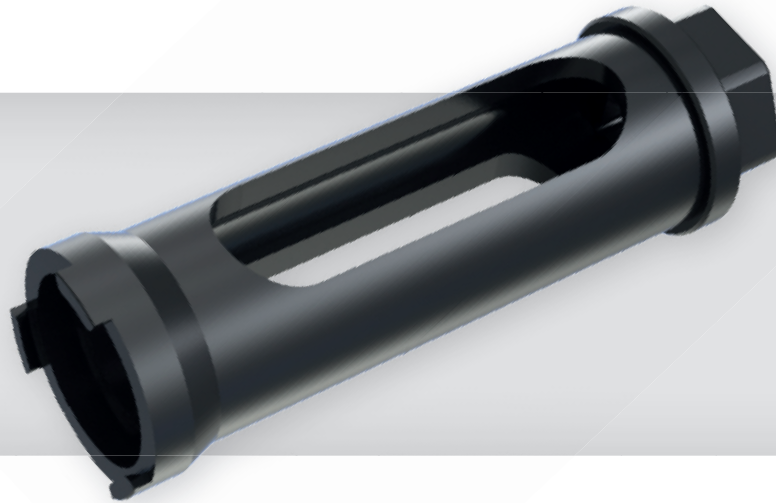

### ZETA-DREHMOMENTSTECKNUSS

ZETA-torque nut

Typ Type	A	H	SW	V	Profil Profile	Artikelnummer Part number
EC 16 Zeta	Ø22	85	17	3/8"	<b>C</b>	STEC16ZETA
EC 20 Zeta	Ø26	90	19	3/8"	<b>D</b>	STEC20ZETA
ECS 20 Zeta	Ø34	102	27	1/2"	<b>K</b>	STECS20ZETA
ECS 25 Zeta	Ø40	112	27	1/2"	<b>L</b>	STECS25ZETA
ECS 32 Zeta	Ø50	122	27	1/2"	<b>M</b>	STECS32ZETA
OC 25 Zeta	Ø41	110	27	1/2"	<b>I</b>	STOC23ZETA

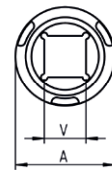
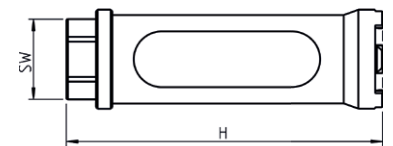

### ZETA-EINDREHHILFE

ZETA-Screw-on-adapter

Typ Type	A	H	SW	V	Profil Profile	Artikelnummer Part number
ED 16 Zeta	Ø22	18	19	-	<b>C</b>	SCHED16ZETA
ED 20 Zeta	Ø26	19	22	-	<b>D</b>	SCHED20ZETA
EDS 20 Zeta	Ø27	19	22	-	<b>K</b>	SCHEDS20ZETA
EDS 25 Zeta	Ø30	20	27	-	<b>L</b>	SCHEDS25ZETA
EDS 32 Zeta	Ø32	21	30	-	<b>M</b>	SCHEDS32ZETA
OD 25 Zeta	Ø41	24	36	-	<b>I</b>	SCHOD25ZETA

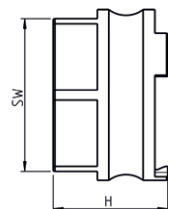
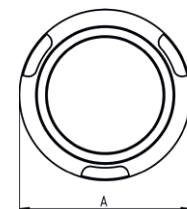

# BEDIENELEMENTE

## OPERATING TOOLS



### ZETA-STANDARDSPANNSCHLÜSSEL

ZETA-Standard spanner wrench

Typ Type	A	L	Profil Profile	Artikelnummer Part number
E 16 Zeta	Ø22	180	<b>C</b>	SCHE16ZETA
E 20 Zeta	Ø26	180	<b>D</b>	SCHE20ZETA
E-SP 20 Zeta	Ø44	175	<b>K</b>	SCHESP20ZETA
E-SP 25 Zeta	Ø30	200	<b>L</b>	SCHESP25ZETA
E-SP 32 Zeta	Ø37	215	<b>M</b>	SCHESP32ZETA
O 25 Zeta	Ø40	215	<b>I</b>	SCHO25ZETA

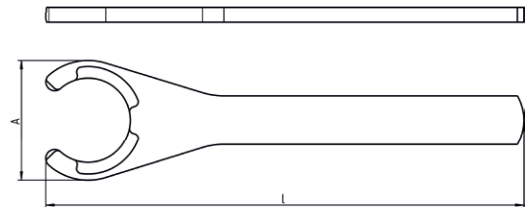

### ZETA-DREHMOMENTADAPTER

ZETA-torque wrench adapter

Typ Type	A	L	Profil Profile	Artikelnummer Part number
ET 16 Zeta	Ø22	-	<b>C</b>	THET16
ET 20 Zeta	Ø26	-	<b>D</b>	THET20
ETET 20 Zeta	Ø44	-	<b>K</b>	THETET20
ETET 25 Zeta	Ø49	-	<b>L</b>	THETET25
ETET 32 Zeta	Ø66	-	<b>M</b>	THETET32
OT 25 Zeta	Ø41	-	<b>I</b>	THOT25

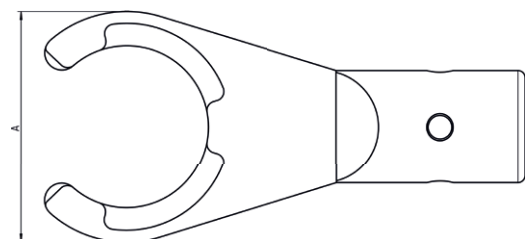

# ZWISCHENRINGE

## SPACERS

### Ø35 x 20

D	B	d	Artikelnummer Part number
35	2	20	ZWR.023520
35	3	20	ZWR.033520
35	4	20	ZWR.043520
35	5	20	ZWR.053520
35	8	20	ZWR.083520
35	10	20	ZWR.103520
35	12	20	ZWR.123520
35	15	20	ZWR.153520
35	20	20	ZWR.203520

### Ø40 x 20

D	B	d	Artikelnummer Part number
40	2	20	ZWR.024020
40	4	20	ZWR.044020
40	8	20	ZWR.084020
40	10	20	ZWR.104020
40	12	20	ZWR.124020
40	16	20	ZWR.164020
40	20	20	ZWR.204020

### Ø42 x 20

D	B	d	Artikelnummer Part number
42	2	20	ZWR024220
42	3	20	ZWR034220
42	5	20	ZWR054220
42	8	20	ZWR084220
42	10	20	ZWR104220
42	12	20	ZWR124220
42	15	20	ZWR154220
42	20	20	ZWR204220

### Ø42 x 31.75

D	B	d	Artikelnummer Part number
42	2	31.75	ZWR024231.75
42	3	31.75	ZWR034231.75
42	5	31.75	ZWR054231.75
42	8	31.75	ZWR084231.75
42	10	31.75	ZWR104231.75
42	12	31.75	ZWR124231.75
42	15	31.75	ZWR154231.75
42	20	31.75	ZWR204231.75



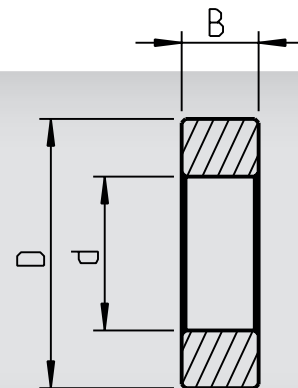

### Ø50 x 20

D	B	d	Artikelnummer Part number
50	2	20	ZWR025020
50	3	20	ZWR035020
50	5	20	ZWR055020
50	8	20	ZWR085020
50	10	20	ZWR105020
50	12	20	ZWR125020
50	15	20	ZWR155020
50	20	20	ZWR205020

### Ø50 x 32

D	B	d	Artikelnummer Part number
50	2	32	ZWR025032
50	3	32	ZWR035032
50	5	32	ZWR055032
50	8	32	ZWR085032
50	10	32	ZWR105032
50	12	32	ZWR125032
50	15	32	ZWR155032
50	20	32	ZWR205032

### Ø50 x 31.75

D	B	d	Artikelnummer Part number
50	2	31.75	ZWR025031.75
50	3	31.75	ZWR035031.75
50	5	31.75	ZWR055031.75
50	8	31.75	ZWR085031.75
50	10	31.75	ZWR105031.75
50	12	31.75	ZWR125031.75
50	15	31.75	ZWR155031.75
50	20	31.75	ZWR205031.75

### Ø70 x 20

D	B	d	Artikelnummer Part number
70	3	20	ZWR.037020
70	5	20	ZWR.057020
70	8	20	ZWR.087020
70	10	20	ZWR.107020
70	15	20	ZWR.157020
70	20	20	ZWR.207020

# MONTAGE- UND MESSVORRICHTUNG

## MOUNTING- AND MEASURING DEVICE

Unsere modulare Montage- und Messvorrichtung bietet Ihnen die Möglichkeit verschiedenste Werkzeugaufnahmen **einfach, sicher und schnell** zu montieren und zu messen. Somit haben Sie eine **Komplettlösung** für alle Werkzeugtypen an nur einer Station. Über weitere Daten und Vorteile informieren wir sie gerne!

*Our modular mounting- and measuring device provides you easy, safe, and fast mounting and measuring of your tools. It functions as an „all in one“ solution for all types of tools. Please contact us for more information.*

### MONTAGE- UND LÄNGENMESSVORRICHTUNG

für HSK Werkzeugaufnahmen, mit digitalem Messsystem

#### MOUNTING- AND MEASURING DEVICE

for HSK tooling, with digital gauge

Nenngröße nominal size	D	Artikelnummer Part number
HSK 40 F	40	DMOHSK-40F
HSK 50 A/E/F	50	DMOHSK-50F



### MONTAGEVORRICHTUNGEN für Schleifdorne

Mounting-devices for grinding wheel holders

Nenngröße nominal size	D	Artikelnummer Part number
HSK 40 F	40	MOHSK-40F
HSK 50 A/E/F	50	MOHSK-50F
BT30	46	MOBT30

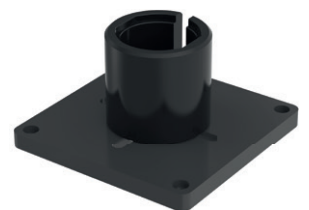

# ZETA-SICHERHEITSSPANNSYSTEME FÜR SCHLEIFDORNE

## ZETA-SAFETY CLAMPING SYSTEMS FOR GRINDING WHEEL HOLDERS

Die patentierten Zeta Sicherheitssysteme bieten Ihnen enorme **Vorteile** gegenüber allen gängigen Spannsystemen. Weitere Informationen entnehmen Sie unserem **Produktkatalog**.

*The patented Zeta collet clamping system provides enormous advantages over current systems. You will find more detailed Informations about this in our product catalog.*

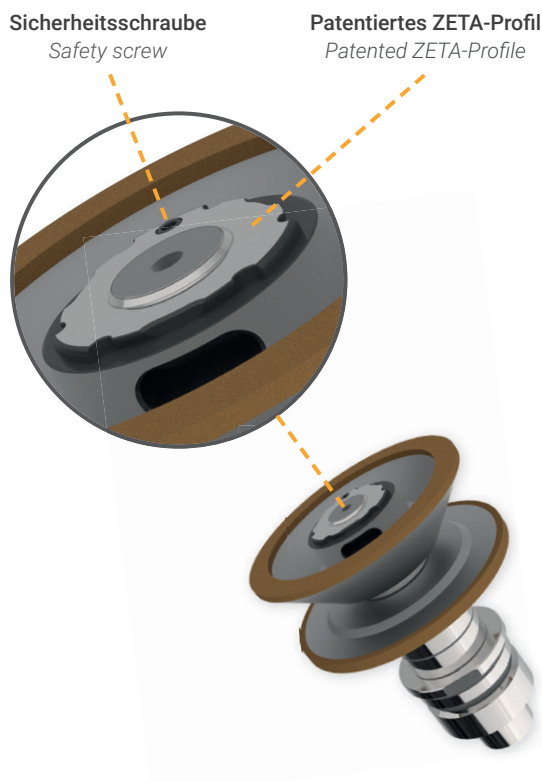

### VORTEILE | ADVANTAGES

- 1** **Einsetzbar von ER8 bis ER50 (DIN 6499) und OZ25 (DIN 6388)**  
*Applicable from ER8 to ER50 (DIN 6499) and OZ25 (DIN 6388)*
- 2** **Stark erhöhte Spannkraft gegenüber herkömmlicher Systeme.**  
*Improved clamping forces over current systems.*
- 3** **Einfaches und schnelles spannen.**  
*Easy and fast to clamp.*
- 4** **Keine Verletzungsgefahr durch abrutschsicheres Spannsystem!**  
*Prevents injury due to unique clamping properties.*
- 5** **Definiertes Anzugsmoment beim Einsatz eines Drehmomentschlüssels.**  
*More accurate clamping forces with use of torque wrench.*

**SCHLEIFAUFNAHMEN SIND FÜR FOLGENDE HERSTELLER VERFÜGBAR:**  
GRINDING WHEEL HOLDER ARE AVAILABLE FOR FOLLOWING BRANDS:



- Anca • Haas
- Hawema • Saacke
- Deckel/Isog • Schneeberger
- Rollomatic • Schütte
- Reinecker • Walter